

Customer Information

Company Name: _____

Address: _____

City: _____

State: _____

Zip: _____

Country: _____

Person in Charge: _____

Position: _____

Phone: _____

Fax: _____

E-Mail: _____





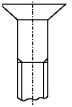
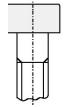
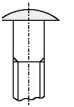
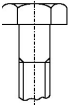
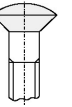
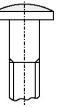
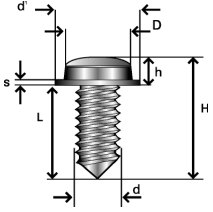

Inquiry

Systems and Tools Currently in Use

<input type="checkbox"/> Photograph(s) attached	<input type="checkbox"/> Video(s) attached	<input type="checkbox"/> Workpiece drawing(s) attached
---	--	--





Screw Technical Features (Check box and fill in values)

							D (mm)	
<input type="checkbox"/>	<input type="checkbox"/>	<input type="checkbox"/>	<input type="checkbox"/>	<input type="checkbox"/>	<input type="checkbox"/>		H (mm)	
<input type="checkbox"/>	<input type="checkbox"/>	<input type="checkbox"/>	<input type="checkbox"/>	<input type="checkbox"/>	<input type="checkbox"/>		L (mm)	
<input type="checkbox"/>	<input type="checkbox"/>	<input type="checkbox"/>	<input type="checkbox"/>	<input type="checkbox"/>	<input type="checkbox"/>		S (mm)	
<input type="checkbox"/>	<input type="checkbox"/>	<input type="checkbox"/>	<input type="checkbox"/>	<input type="checkbox"/>	<input type="checkbox"/>		d (mm)	
<input type="checkbox"/>	<input type="checkbox"/>	<input type="checkbox"/>	<input type="checkbox"/>	<input type="checkbox"/>	<input type="checkbox"/>		h (mm)	
<input type="checkbox"/>	<input type="checkbox"/>	<input type="checkbox"/>	<input type="checkbox"/>	<input type="checkbox"/>	<input type="checkbox"/>		d' (mm)	

						<input type="checkbox"/> Other
<input type="checkbox"/>	<input type="checkbox"/>	<input type="checkbox"/>	<input type="checkbox"/>	<input type="checkbox"/>	<input type="checkbox"/>	<input type="checkbox"/>

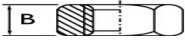
ASG, Division of Jergens, Inc.

Special End Attachments

Nut Technical Features (Check box and fill in values)				Specify Dimensions (mm)	
				Hex	
<input type="checkbox"/>	<input type="checkbox"/>	<input type="checkbox"/>	<input type="checkbox"/>	C (H Hex)	
<input type="checkbox"/>	<input type="checkbox"/>	<input type="checkbox"/>	<input type="checkbox"/>	D (H Tot)	
Standard Hexagonal	Hexagonal w/ Washer	Self Locking Hexagonal	Blind Hexagonal		

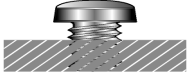
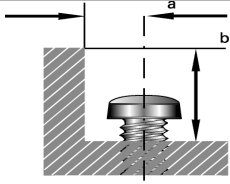
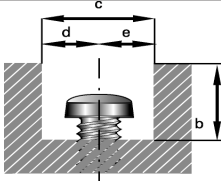
Position of Tightening (Check box and fill in values)			Specify Dimensions (mm)	
			a =	
<input type="checkbox"/>	<input type="checkbox"/>	<input type="checkbox"/>	b =	
<input type="checkbox"/>	<input type="checkbox"/>	<input type="checkbox"/>	c =	
<input type="checkbox"/>	<input type="checkbox"/>	<input type="checkbox"/>	d =	
<input type="checkbox"/>	<input type="checkbox"/>	<input type="checkbox"/>	e =	
Plane Surface without Obstruct	Near to Wall	Embedded		

Specifications	
Torque (N.m)	
Accuracy (%)	
Speed (RPM)	
Feed Pressure (PSI, Bar)	
Capacity Production	
• Number of Pieces/Minute	
• Number of Pieces/Hour	
• Number of Pieces/Day	

Materials		
<input type="checkbox"/>	Wood	Steel
<input type="checkbox"/>	Plastic	Iron
<input type="checkbox"/>	Aluminum	Other

Type of Screwdriver Requested			
<input type="checkbox"/>	Inline with Push to Start	Pistol Grip	With Angle Head at 30°
<input type="checkbox"/>	Inline with Lever Start	Forward Pistol Grip	With Angle Head at 90°
<input type="checkbox"/>		Upprip Pistol	With Flat Head
<input type="checkbox"/>			With Flat Head Inline
<input type="checkbox"/>	Air Screwdriver	Electric Screwdriver	
<input type="checkbox"/>	Operator in Sit Down Position	Operator in Stand Up Position	

ASG, Division of Jergens, Inc.

Flat Head

It is necessary to send drawing samples and pictures of the work piece

Dimensions in mm								
	Min	Max		Min	Max		Min	Max
A			D3			L1		
AL			H			R (from hex center)		
B			H1			SW		
C			H2			SW1		
D1			H3					
D2			L					

Tightening Direction	
	Right
	Left

Possibility of Head Direction with Respect to the Tightening Axis	
Towards Right Degrees	
Towards Left Degrees	

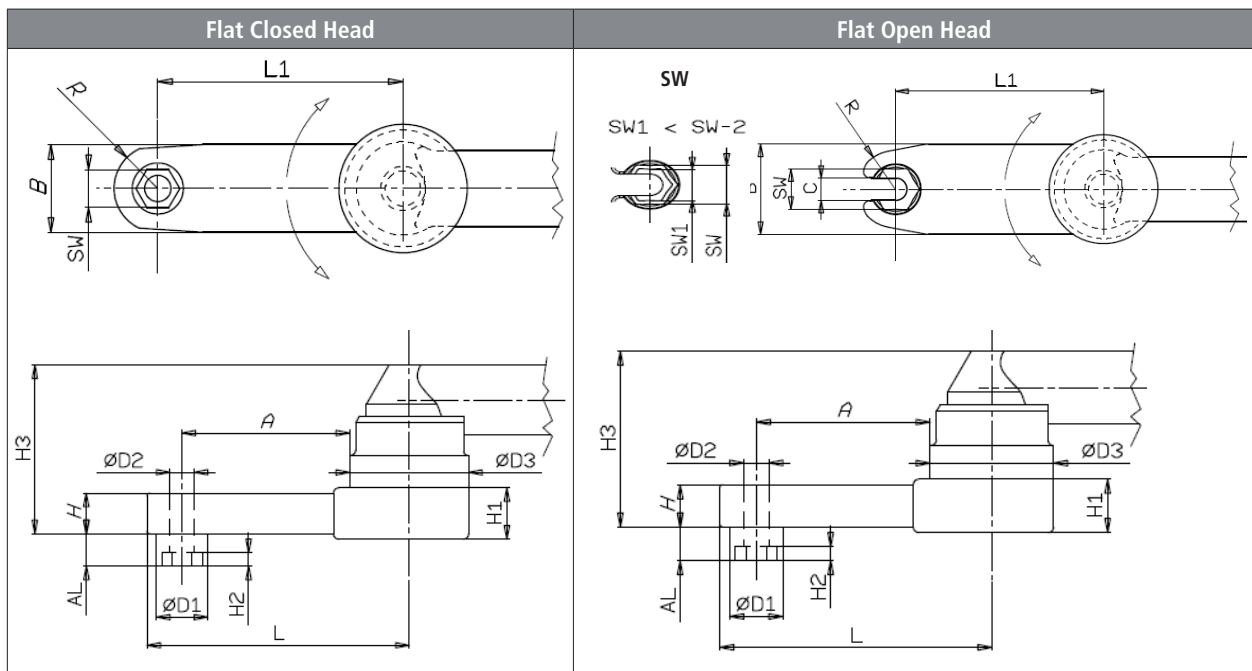

SW Features (Check box)	
<input type="checkbox"/>	Hexagonal
<input type="checkbox"/>	Double Hexagonal* Fill in Values (mm)
<input type="checkbox"/>	Polygonal
<input type="checkbox"/>	Square
<input type="checkbox"/>	Other Type:
<input type="checkbox"/>	Blind Gear - Has a "ridge" on which the nut sits, making tightening easier
<input type="checkbox"/>	Through Gear - Has a hex drive that covers the nut completely

* The difference between the two hexagons SW and SW1 should be equal or higher than 2mm

ASG, Division of Jergens, Inc.

Flat Head Inline

It is necessary to send drawing samples and pictures of the work piece

Dimensions in mm								
	Min	Max		Min	Max		Min	Max
AL			D2			L1		
B			H			R (from hex center)		
C			H1			SW		
D			H2			SW1		
D1			L					

Tightening Direction	
	Right
	Left

Possibility of Head Direction with Respect to the Tightening Axis	
	Towards Right Degrees
	Towards Left Degrees

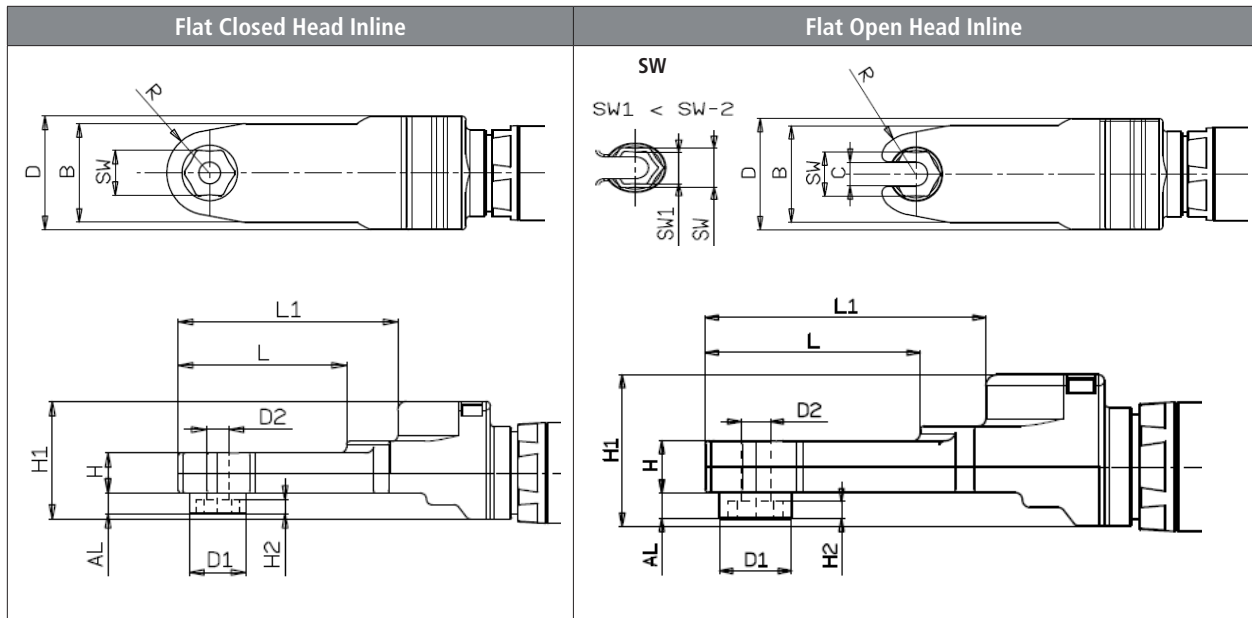

SW Features (Check box)		
<input type="checkbox"/>	Hexagonal	
<input type="checkbox"/>	Double Hexagonal*	Fill in values (mm)
<input type="checkbox"/>	Polygonal	
<input type="checkbox"/>	Square	
<input type="checkbox"/>	Other Type	
<input type="checkbox"/>	Blind Gear - Has a "ridge" on which the nut sits, making tightening easier	
<input type="checkbox"/>	Through Gear - Has a hex drive that covers the nut completely	

* The difference between the two hexagons SW and SW1 should be equal or higher than 2mm

ASG, Division of Jergens, Inc.

Special End Attachments

Checklist			
Yes	No		
		Screw Samples/Drawings Sent	Quantity:
		Pieces Samples/Drawings Sent	Quantity:
		Enclosed Layout of Work Place and Eventual Restrictions	
		Ergonomic Needs	

Quantity Requested (Pieces)	
Delivery Time Requested	
Available Budget	
Competitors	

Additional Information:

Filled in By: _____

Date: _____

Other Details: _____

ASG, Division of Jergens, Inc.